

Nu:Tekt HA-KIT

Owner's Manual
取扱説明書

E J 1

KORG INC. 4015-2 Yanokuchi, Inagi-City, Tokyo 206-0812 JAPAN
©2018 KORG INC. www.korg.com

This kit is intended for those who have experience building electronic kits and who have a basic understanding of soldering and electronic parts.

If you make a mistake during assembly, connected devices may be damaged, or the electronic parts in this kit may be damaged or become hot.

After assembling this kit and before turning on the power, make sure to check for any mistakes in mounting or imperfect solder points.

Table of Contents

Main features	3
Cautions Before Assembly	5
Tools to prepare.....	5
Checking the parts.....	5
Mounting Diagram	6
List of mounted parts	7
Mounting the Circuit Board	9
Building the main circuit board	9
Building the Nutube circuit board unit.....	10
Attaching the Nutube circuit board unit.....	10
Attaching the hex spacers	11
Checking the main circuit board operations	11
Adjusting the main circuit board	12
Where to adjust	12
How to adjust	12
Replacing the operational amplifier	12
Assembly	13
Parts List.....	13
Assembly.....	14
Troubleshooting	16
Part Names and Functions	16
Specifications	16

Precautions

Location

Using the unit in the following locations can result in a malfunction.

- In direct sunlight
- Locations of extreme temperature or humidity
- Excessively dusty or dirty locations
- Locations of excessive vibration
- Close to magnetic fields

Power supply

Be sure to turn the power switch to OFF when the unit is not in use. Remove the battery in order to prevent it from leaking when the unit is not in use for extended periods.

Handling

To avoid breakage, do not apply excessive force to the switches or controls.

Care

If the exterior becomes dirty, wipe it with a clean, dry cloth. Do not use liquid cleaners such as benzene or thinner, or cleaning compounds or flammable polishes.

Keep this manual

After reading this manual, please keep it for later reference.

Keeping foreign matter out of your equipment

Never set any container with liquid in it near this equipment. If liquid gets into the equipment, it could cause a breakdown, fire, or electrical shock. Be careful not to let metal objects get into the equipment.

Notice regarding disposal (EU only)



If this symbol is shown on the product, manual, battery, or package, you must dispose of it in the correct manner to avoid harm to human health or damage to the environment. Contact your local administrative body for details on the correct disposal method. If the battery contains heavy metals in excess of the regulated amount, a chemical symbol is displayed below the symbol on the battery or battery package.



IMPORTANT NOTICE TO CONSUMERS

This product has been manufactured according to strict specifications and voltage requirements that are applicable in the country in which it is intended that this product should be used. If you have purchased this product via the internet, through mail order, and/or via a telephone sale, you must verify that this product is intended to be used in the country in which you reside.

WARNING: Use of this product in any country other than that for which it is intended could be dangerous and could invalidate the manufacturer's or distributor's warranty. Please also retain your receipt as proof of purchase otherwise your product may be disqualified from the manufacturer's or distributor's warranty. Company names, product names, and names of formats etc. are the trademarks or registered trademarks of their respective owners.

* All product names and company names are the trademarks or registered trademarks of their respective owners.

Thank you for purchasing the Nu:Tekt HA-KIT.

To help you get the most out of your new instrument, please read this manual carefully.

Main features

- The HA-Kit is a kit for assembling the headphone amp that uses the Nutube.
- Although this headphone amp is powered with only two batteries, it can drive the Nutube with a line voltage of 26 V for an authentic vacuum tube sound.
- The filament is powered by a DC to DC converter, which consumes less electric current.
- The amp features an EDM switch, which is used for boosting the low end on EDM (electronic dance music) or when using headphones.
- The headphone amp output uses an IC socket, which allows the operational amplifier to be replaced. Two types of operational amplifiers are included.
- The Nutube anode load resistance value can be adjusted, letting you enjoy different sounds by changing the steepness of the load curve for the vacuum tube.
- This unit is shaped like a mint can case, which is familiar to fans of these kinds of cases. –The unit also includes a protector for the power switch.
- An acrylic cover is provided that features the Nu:Tekt design, letting you see the light from the Nutube through the cover.
- If you are concerned about whether you can assemble this kit or whether you might make a mistake, refer to the video explanations available on the Web, or use our assembly service support (chargeable).

About Nutube

Nutube is a new vacuum tube developed by KORG INC. and Noritake Itron Corporation and that utilizes technology from vacuum fluorescent displays. As with conventional vacuum tubes, the Nutube is constructed with an anode, grid and filament, and operates as a complete triode tube. Furthermore, it generates the response and same rich harmonic characteristics of conventional vacuum tubes.



If a strong impact is applied to this unit, noise at the high-frequency range may be output. This is due to the structure of the Nutube; it is not a malfunction.

What is “Nu:Tekt”?

Nu:Tekt is an dedicated brand for kits, marketed by electronic musical instrument manufacturer Korg. Nu:Tekt offers sales and service for a unique brand of kits beginning with the new “Nutube” vacuum tube as well as musical instruments and audio devices, made possible through Korg’s experience as a musical instrument manufacturer.

Nu:Tekt web site: www.nutekt.org

Cautions Before Assembly

Be careful of injury when handling parts

Use caution not to injure yourself due to the protruding parts when handling the circuit board. Use cotton work gloves to protect your hands when working. Also, be sure to wash your hands thoroughly after working.

Tighten screws and nuts at a perpendicular angle

Tightening screws and nuts that are inserted diagonally may damage the threads, making it impossible to tighten them again. Be sure to tighten screws so that they are inserted perpendicular to the surface. Use caution, as applying too much torque and tightening the screws too tightly may damage the parts.

Do not injure yourself or scratch the surface with the tools.

When using tools to tighten screws and nuts, make sure not to injure yourself, such as by getting your fingers pinched. Work carefully to avoid scratching the case or circuit board with the tools. Provide a sufficiently large work space to complete the assembly procedure, and prepare work mats so parts will not be scratched.

Avoid losing the screws and nuts

Handle the screws and nuts with caution, to avoid losing them. Do not use other screws or nuts aside from the ones included with this kit, and do not use the screws and nuts included with this kit for any other purpose.

Tools to prepare

You will need the following tools in order to assemble this kit.

Note: You will also need a battery, solder, glue, adhesive tape and so on. These items are not included, so please obtain them separately.

- **Soldering iron**
- **Nippers, needle-nose pliers, tweezers**
- **Precision screwdriver (Phillips head No. 0, No. 1, flathead 2.4 mm)**
Use a screwdriver that matches the size of the screw. Using the wrong size of screwdriver may damage the screw or make it impossible to tighten.
- **Hex wrench (1.5 mm)**
- **Wrench (two-sided, 10 mm/11 mm wide)**
- **Tester**

Checking the parts

Before assembly, make sure that all parts are on hand.

Contact us at www.nutek.org if any parts are missing or damaged.

Mounting Diagram

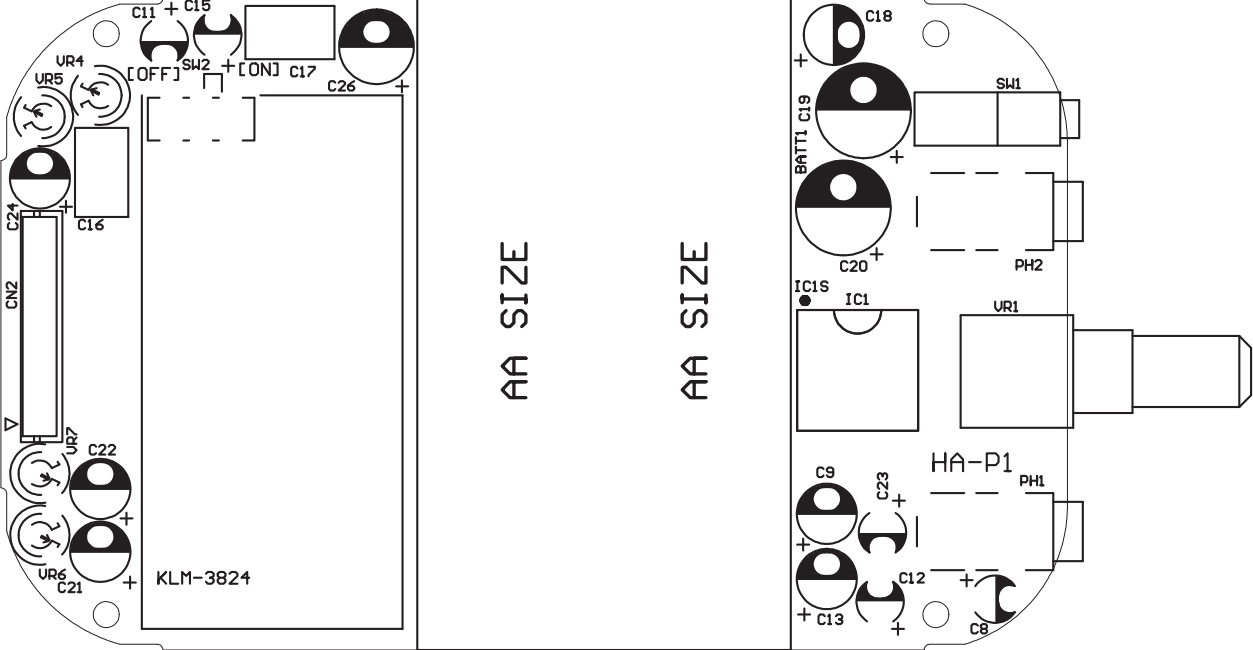

List of mounted parts

Main circuit board

Part number	Circuit number	Part name	Rating	Quantity
1	IC1	Operational amplifier	NJM4580	1
			MUSES01	1
2	IC1S	Operational amplifier socket	8pin DIP	1
3	C10, C14	Chip ceramic capacitor	10PF CH	2
4	C27, C28	Chip ceramic capacitor	0.0022 μ F B	2
5	C16, C17	Film capacitor	0.012 μ F FILM	2
6	C8, C11, C12, C15, C23	Electrolytic capacitor	10 μ F/25V	5
7	C9, C13	Non-polar capacitor	10 μ F/25V BP	2
8	C21, C22	Electrolytic capacitor	47 μ F/16V	2
9	C26	Electrolytic capacitor	100 μ F/35V	1
10	C19, C20	Electrolytic capacitor	220 μ F/25V	2
11	C24	Electrolytic capacitor	220 μ F/6.3V	1
12	C18	Electrolytic capacitor	OPEN	--
13	R16	Chip resistor	0	1
14	R29, R30	Chip resistor	10 1/4W	2
15	R32	Chip resistor	1K	1
16	R35, R36	Chip resistor	4.7K	2
17	R6, R7, R21, R24, R26, R28	Chip resistor	10K	6
18	R8, R9	Chip resistor	22K	2

19	R10, R12, R17, R18	Chip resistor	47K	4
20	R14, R15, R20, R23	Chip resistor	100K	4
21	BATT1	Battery box	BATTERY BOX	1
22		"+" side electrode		2
23		"-" side electrode		2
24	CN2	Connector	B12B-ZR	1
25	PH1, PH2	Stereo mini phone jack	PJ-321	2
26	SW2	Slide switch	MK-22D10-G2	1
27	SW1	Toggle switch	ZUD1-T1	1
28	VR6, VR7	Trimmer Potentiometer	10K B	2
29	VR1	Volume	100K A	1
30	VR4, VR5	Trimmer Potentiometer	200K B	2
31		Hex spacers	M2, L=3mm	2
32		Hex spacers	M2, L=16mm	4
33		Internal tooth lock washers	M2	4
34		Screws	M2x5	2
35		Harness		1

* Parts highlighted in gray are already mounted.

Nutube circuit board

Part number	Circuit number	Part name	Rating	Quantity
36	IC3	Voltage regulator	TLV61046A	1
37	IC2	Voltage regulator	TPS62510	1
38	Q1, Q2	J-FET	2SK209	2
39	C4	Chip ceramic capacitor	22PF CH	1
40	C5	Chip ceramic capacitor	0.001μF B	1
41	C3	Chip ceramic capacitor	0.1μF B	1
42	C6	Chip ceramic capacitor	4.7μF B	1
43	C7	Chip ceramic capacitor	4.7μF B	1
44	C1, C2	Chip ceramic capacitor	22μF B	2
45	C25	Chip Electrolytic capacitor	390μF/2.5V	1
46	C29, C30, C31, C32	Chip ceramic capacitor	10μF B	--
47	R33	Chip resistor	0	1
48	R1	Chip resistor	1	1
49	R31	Chip resistor	6.2	1
50	R11, R13	Chip resistor	10K	2
51	R3, R5	Chip resistor	62K	2
52	R2	Chip resistor	120K	1
53	R4	Chip resistor	2M	1
54	R34	Chip resistor	OPEN	1
55	L1	Chip inductor	2.2μH	1
56	L2	Chip inductor	10μH	1
57	CN1	Connector	S12B-ZR	1

58	V1	Nutube (vacuum tube)	Nutube 6P1	1
59		Nutube rubber	CR Rubber 1t, 16x32	1
60		Circuit board cushion	PORON 7t, 8x19	1
61		Cushion N1	Sponge 1t, 5x40	2
62		Cushion N2	Sponge 1t, 5x15	2

* Parts highlighted in gray are already mounted.

Note: The quantities of parts shown on this list are the number of parts actually used. The kit may contain some extra parts that are not used.

Mounting the Circuit Board

Building the main circuit board

Starting from the shorter parts, attach and solder the parts while referring to the list of mounted parts and the mounting diagram. Be careful not to get the parts mixed up.

You might find it easy to work by following the steps below.

Soldering the parts

1. Solder the slide switch (26).

Solder the slide switch carefully so that it is flush with the circuit board without being slanted.

2. Solder the trimmer potentiometers (28, 30) and the volume VR1 (29).

Solder the volume carefully so that it is flush with the circuit board without being slanted.

3. Solder the film capacitors (5).

4. Solder the connector (24).

Be sure to mount the parts in the correct direction. If the symbols do not match those shown on the circuit board, the connector is facing the wrong way.

5. Solder the stereo mini phone jack (25).

6. Solder the toggle switch (27).

Solder the toggle switch carefully so that it is flush with the circuit board without being slanted.

7. Solder the operational amplifier socket (2).

Be sure to install the part in the correct direction.

8. Solder the non-polar electrolytic capacitor (7).

TIP The non-polar electrolytic capacitor (7) does not have polarity.

9. Solder the electrolytic capacitors (5, 8-12).

The electrolytic capacitors have polarities, so make sure to mount them in the right direction.

10. Attach the battery box (21).

Insert the electrodes (22, 23) into the battery box, and solder the battery box onto the circuit board.

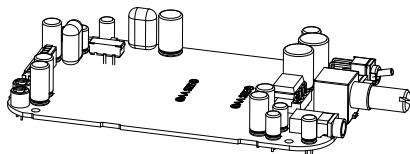
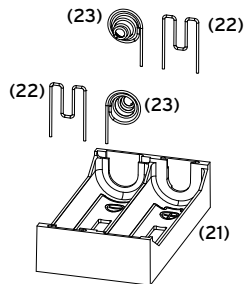

11. Install the operational amplifier (1) in the socket.

Install the pin #1 of the operational amplifier (shown with a mark) so that it lines up with the dot on the circuit board. Be sure to mount the part in the correct direction.

Building the Nutube circuit board unit

1. **Attach the Nutube rubber (59) to the back side of the Nutube (58), as shown in the diagram.**

When attaching the Nutube rubber, make sure that it does not touch the sealing lid of the Nutube.

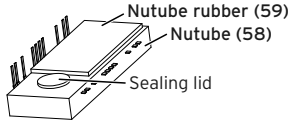

2. **Solder the Nutube (58) onto the side of the Nutube circuit board with the screen-printed surface.**

After making sure that all of the Nutube pins have been inserted into the holes on the circuit board, peel off the release paper on the Nutube rubber. Mount the rubber so that it is flush with the Nutube circuit board, and then solder.

3. **Peel off the release paper from one side of the circuit board cushion (60), and attach it to the back side of the Nutube circuit board.**

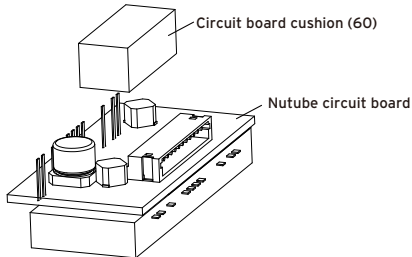

4. **Attach the cushion onto the Nutube circuit board unit.**

Attach cushion N1 (61) onto the edge of the Nutube circuit board. Attach cushion N2 (62) onto both upper edges of the Nutube.

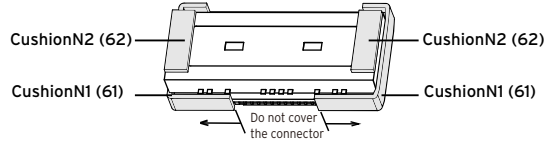

Attaching the Nutube circuit board unit

1. **Connect the Nutube circuit board unit and the main circuit board with the harness (35).**



Do not use excessive force, as the wire can easily break. Also, do not repeatedly connect and disconnect the harness.

2. **Remove the release paper on the circuit board cushion (60) that you attached to the Nutube circuit board, and attach the circuit board unit to the main circuit board.**

Make sure that the Nutube does not touch the adjacent parts or the case.

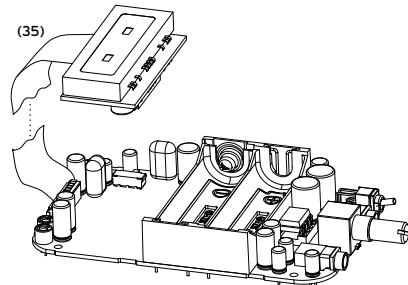

Attaching the hex spacers

1. Mount the hex spacers (31, 32) onto the circuit board.

Use the screws (34) to affix the two hex spacers (32) and the internal tooth lock washers (33) for the volume and jack side. In the same way, tighten the hex spacers on the Nutube circuit board side (32) and the internal tooth lock washers (33) by tightening the screws for the lower hex spacers (31).

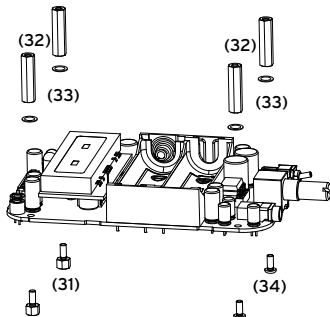

 Since the screws (34) cannot be retightened from the outside of the case, use a precision screwdriver (Phillips #1) to firmly tighten the screws.

Checking the main circuit board operations

After you have assembled all of the parts, make sure that no parts are remaining. Starting from the beginning, follow each step while referring to the assembly instructions, to make sure that the unit has been properly assembled.

Before turning on the power, make sure to check the following.

- Are the parts mounted in the correct place?
- Are the parts mounted in the correct direction?
- Did you leave any bridges or other imperfections when soldering?
- Is the power line free from short circuits?

1. Turn the toggle switch off (downwards).

2. Insert the batteries into the battery box.

Be sure that the batteries are facing the proper direction.



Batteries are not included with this kit. You will need to purchase two commercially available AA alkaline batteries.

3. Turn on the power.

If the Nutube does not light up at this time, you may have made a mistake during assembly. Turn off the power immediately, and check to make sure that there are no mistakes in assembly.

TIP Note that the brightness of the Nutube may look different from left to right.

Adjusting the main circuit board

Where to adjust

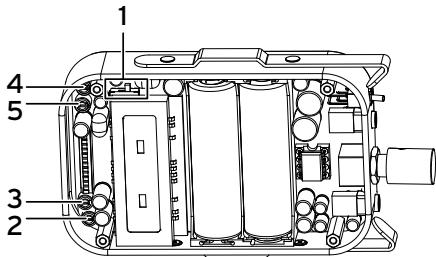

- 1. EDM switch**
This is a low-end boost switch to make the sound more appropriate for music such as EDM. Adjust this according to your tastes.
- 2. BIAS(L)(VR6)**
- 3. BIAS(R)(VR7)**
This sets the Nutube bias voltage.
- 4. Anode Load(L)(VR4)**
- 5. Anode Load(R)(VR5)**
This adjusts the Nutube's anode load resistance.

How to adjust

- 1. Turn VR 4 and 5 (29) all the way to the right.**
In general, the unit is used with VR 4 and 5 turned all the way to the right. However, since the tonal character of the sound changes according to the load resistance, adjust VR 4 and 5 to get the sound that you like.
TIP Turning VR 4 and 5 all the way to the left will result in no sound.
- 2. Turn the volume VR1 all the way to the left.**
Connect an appropriate sound source to the input and turn the volume up gradually while checking the sound in headphones or earphones.
- 3. Adjust VR6 and 7 (27) while listening to the sound, in order to achieve maximum volume.**
The above steps show the basic method to adjust the sound. If you notice a difference in volume between left and right, adjust fixed resistors VR 4, 5, 6, and 7 (27, 29) to balance the levels between left and right. When you change the bias voltage and anode load resistance values, the tonal character will change. Adjust the settings to get the sound you like.
TIP You may hear a crackling sound when turning the VR4, 5, 6 or 7 fixed resistors while playing sound, but this is not a malfunction.
TIP Turning the fixed resistors (VR 4, 5) all the way to the left will result in no sound.

Replacing the operational amplifier

The operational amplifier can be replaced with a DIP8 or SOP type operational amplifier. (When replacing, be sure to use only one.) The power supply for the OP amp is a 24–28 V single power supply system. When replacing the operational amplifier, be sure that the replacement uses the same rated voltage.

-  Replacing the operational amplifier with any other operational amplifier besides the one included with this kit is to be done on your own responsibility.

Assembly

Parts List

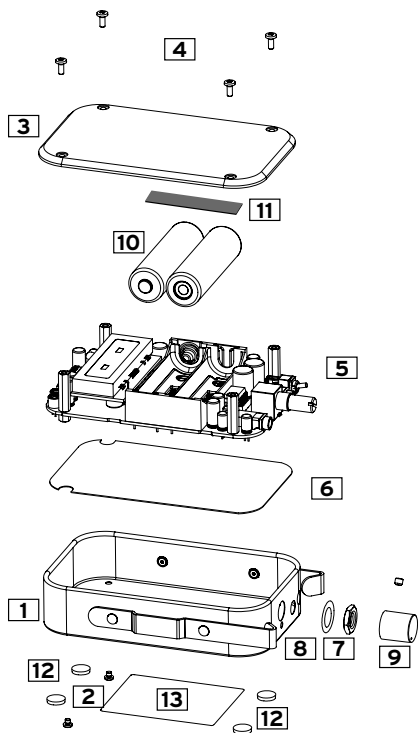

1	case	Mint-tin size case	1
2	Pan head screws	M2, No.0, L=2mm	2
3	Cover	Resin treatment	1
4	Hexagon socket set screw	M2, L=6mm	4
5	Main circuit board	Parts for assembly on pages 9, 10 and 11	1
6	Insulation sheet	PET	1
7	Volume nut	Included with Volume	1
8	Volume washer	Included with Volume	1
9	Volume knob		1
10	Battery	AA alkaline batteries (sold separately)	2
11	Battery cushion	1t, 30 x 10	1
12	Rubber feet		4
13	Rating label		1



Make sure not to lose any of the small screws.

Assembly

1. Put the insulation sheet [6] into the case [1].

Peel off the release paper on the double-sided tape attached to the insulation sheet [6], and attach it to the case [1].

Double-sided tape (bottom side)

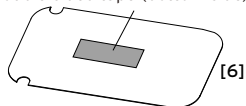

Be careful not to cover the screw holes.

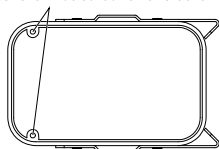
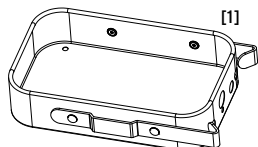

2. Slide the main circuit board (assembled) into the case [1] to mount.

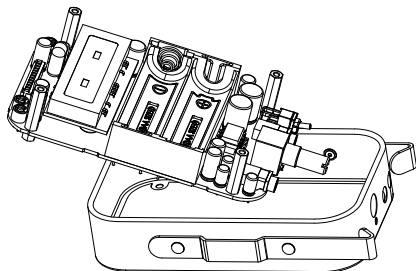

3. Attach the washer [8] to the volume, and then use the volume nut [7] to temporarily tighten the volume onto the case.

Make sure that the stereo mini jack protrudes from the hole in the case.

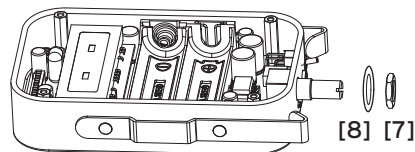

4. Fix the main circuit board in place by screwing the pan head screws [2] into the two holes at the bottom of the case.

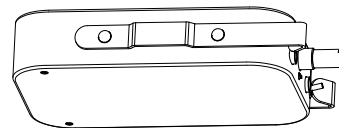

TIP Use a precision screwdriver (Phillips #0) to tighten the screws.

5. Retighten the volume nut [7] to be fixed in place.

6. Attach the knob [9] onto the volume.

Mount the volume knob onto this spindle.

Tighten the fastener screw with a hex wrench.

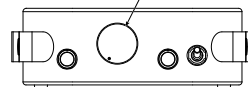

7. Put the batteries [10] in.

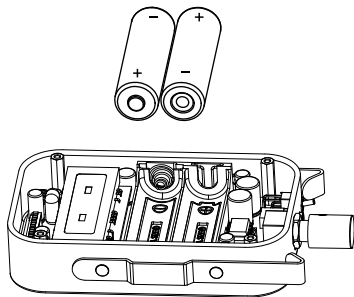

 Batteries are not included. You will need to purchase a commercially available AA alkaline batteries.

8. Peel off the protective sheet on the cover [3], and attach the battery cushion [11].

A protective sheet is attached to both sides of the cover. After peeling off the protective sheet on the back side, attach the battery cushion in the position shown in the diagram below.

TIP If the protective sheet is hard to peel off, use adhesive tape to make it easier to peel off.



9. With the printed jack names facing the jack side, put the cover [3] on, and fasten the hexagon socket set screws [4] in four places.

 Take care not to pinch the harness or other parts when closing the cover.

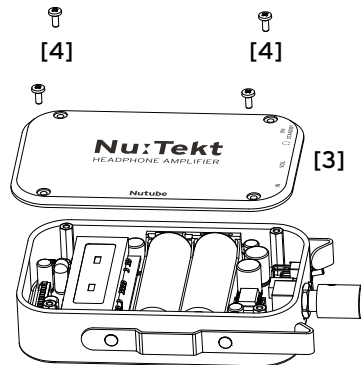

10. Attach the rubber feet [4] onto the case.

Attach the rubber feet [12] and rating label [13] so that they do not overlap, as shown in the diagram.

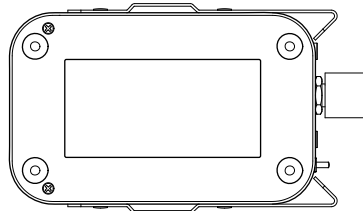

Troubleshooting

When you have successfully finished assembling the unit, test its operation while reading “Part Names and Functions” .

If you have found any problems with assembly or operation, use the troubleshooting steps below.

Some parts are left over.

- The kit may contain some extra parts that are not used, such as resistors or capacitors.

There aren't enough parts.

- If you have lost some parts, contact us at www.nutekt.org.
- Also, contact us at www.nutekt.org if any parts were missing or damaged before you started to assemble the unit.

I can't assemble the unit, because I broke a part.

- Please contact us at www.nutekt.org.

The unit makes an abnormal sound when I tilted it or shook it after assembly.

- A loose screw or other part might be left inside the unit. Open the lower case and check the inside.

The volume or jacks are loose.

- Make sure that the nuts are fastened tightly. Remove the knobs from the volume and retighten the nuts.

The sound is distorted.

- The input levels may be set too high. Adjust the volume level on the input device.

Part Names and Functions

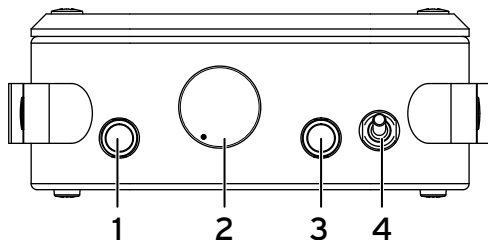

1. IN: Connect a portable music player or similar device here.

2. VOL: Used for adjusting the volume.

3.  : Connect a pair of headphones or stereo earphones.

4. ON/STANDBY: Turns on/off the device.

Specifications

- **Vacuum tube:** Nutube 6P1
- **Connectors and jacks:** IN jack (stereo mini phone jack),  jack (stereo mini phone jack)
- **Controls:** Volume, EDM switch (internal)
- **Output impedance:** 10 Ω ; recommended load: 15 Ω or greater
- **Power:** AA alkaline batteries (sold separately)
- **Battery life:** Approx. 9 hr. (using alkaline batteries)
- **Dimensions (W x D x H):** 111 x 65 x 29 mm / 4.37" x 2.56" x 1.14"
- **Weight:** 110 g / 3.88 oz. (without batteries)
- **Included items:** Owner's Manual

* Specifications and appearance are subject to change without notice for improvement.